

## 13.4.8. Options for Water-level Control in Developed Wetlands

J. R. Kelley, Jr.<sup>1</sup>, M. K. Laubhan<sup>2</sup>, F. A. Reid<sup>3</sup>,  
J. S. Wortham, and L. H. Fredrickson  
*Gaylord Memorial Laboratory  
The School of Natural Resources  
University of Missouri  
Puxico, Missouri 63960*

Wetland habitats in the United States currently are lost at a rate of 260,000 acres/year (105,218 ha/year). Consequently, water birds concentrate in fewer and smaller areas. Such concentrations may deplete food supplies and influence behavior, physiology, and survival. Continued losses increase the importance of sound management of the remaining wetlands because water birds depend on them.

Human activities modified the natural hydrology of most remaining wetlands in the conterminous United States, and such hydrologic alterations frequently reduce wetland productivity. The restoration of original wetland functions and productivity often requires the development of water distribution and discharge systems to emulate natural hydrologic regimes.

<sup>1</sup> Present address: National Biological Survey, Office of Migratory Bird Management, Laurel, Maryland 20708.

<sup>2</sup> Present address: National Biological Survey, National Ecology Research Center, 4512 McMurtry Avenue, Fort Collins, Colorado 80525.

<sup>3</sup> Present address: Ducks Unlimited, Inc., Western Regional Office, 9823 Old Winery Place, #16, Sacramento, California 95827.



Construction of levees and correct placement of control structures and water-delivery and water-discharge systems are necessary to (1) create soil and water conditions for the germination of desirable plants, (2) control nuisance vegetation, (3) promote the production of invertebrates, and (4) make foods available for wildlife that depends on wetlands (Leaflets 13.2.1 and 13.4.6). This paper provides basic guidelines for the design of wetlands that benefit wildlife. If biological considerations are not incorporated into such designs, the capability of managing wetlands for water birds is reduced and costs often are greater.

Although we address the development of palustrine wetlands in migration and wintering areas, many of the discussed principles are applicable to the development of other wetland types and in other locations.

### Levees

#### *Placement*

A primary goal of the development and management of wetlands is the maximization of the amount of flooded habitat. Consequently, levees often are constructed to impound water across large areas with little regard for significant changes in elevation. Because the size and placement of levees were neglected, large portions may be flooded to depths that preclude foraging by some water birds.

Levee placement should be compatible with the natural topography. Contour levees facilitate an efficient and precise control of water in an entire impoundment. As a result, the composition of the vegetation can be controlled more reliably and foods can be made more readily available. Contour intervals on which to construct levees should be established by balancing construction costs, detrimental effects on existing habitats, and the extent and desirable depth of the flooded area. For example, levees on 8-inch (20.3 cm) contours may be appropriate for managing herbaceous vegetation. In contrast, levees for impounding water in forested habitats with similar topographic variation may have to be on a greater contour interval to reduce the number of trees that must be removed. Furthermore, development should not proceed where numerous contour levees in a small area are required.

### *Permanent Levees*

Because they permit control of water levels and dictate the maximum water depth in an impoundment, permanent levees are an integral component of developed wetlands.<sup>1</sup> In addition, permanent levees often are used to form header ditches for the movement of water from sources to the impoundment. Although the dimensions of permanent levees vary by wetland type (permanent, semipermanent, seasonally flooded) and proposed function, the design must be based on engineering criteria.

Appropriate soils must be used for levees to ensure long-term integrity. Because soils have different physical and chemical properties (such as organic-matter content and texture) that affect their suitability as construction material, not all soils can be used to build levees. For example, because of their high susceptibility to water seepage and low erosion potential, coarse sandy soils are poorly suited for levee material. Similarly, soils of mostly organic materials often are unsuitable because of their high potential to shrink and swell. In general, clays or silty clay loams are best suited as levee material because they are highly compactible and have a low shrink-swell potential. Local Soil Conservation Service offices can provide assistance with

obtaining recommended engineering specifications for levees with specific soil types.

Levees should be seeded with non-woody vegetation to help bind the soil and reduce wind and wave erosion. Mixtures of cool-season grasses, warm-season grasses, or both have been used successfully. Because the most appropriate species vary by location and management objectives, a list of desirable species should be obtained from a local extension specialist.

After engineering criteria are satisfied, management goals also should be considered before construction. Levees should be capable of supporting equipment (e.g., tractor, mower, disk) for their maintenance and the control of vegetation in the impoundment. The side slopes of levees should be gradual to allow easy, safe maintenance and deter potential damage by burrowing mammals such as nutria, muskrat, or beaver. Levees with 12-foot (3.7 m) crowns and minimum side slopes of 4:1 or 5:1 usually are satisfactory (Fig. 1). Levees with more gradual side slopes require a greater volume of material, increase construction costs, and destroy more wetland habitat but may be needed to satisfy engineering requirements for some soil types.

The width and height of levees also depend on the size of the impoundment and desirable depth of flooding. Large impoundments (>80 acres [ $>32$  ha]) and impoundments that function as permanently flooded wetlands are subject to severe wave action that increases the risk of erosion. Consequently, large or deeply flooded impoundments require more substantial levees than smaller or seasonally flooded impoundments. As a general rule, the levee height should be at least 1.0 to 1.5 feet (0.3–0.5 m) above the maximum planned flooding depth. Based on these guidelines, levees of permanently and semipermanently flooded impoundments (4–5 foot [1.2–1.5 m] water depths) should have a minimum height of 6 feet (1.8 m), whereas the levee height of seasonally flooded impoundments (4–18 inch [10–46 cm] water depth) should be a minimum of 3 feet (0.9 m). Where unplanned severe flooding occurs regularly, as along rivers, a low levee that is submerged quickly and uniformly often is damaged less by flooding than a large protective levee that is partially overtopped. Where unplanned flood events are less severe or only infrequent, protected (e.g., rip-rapped) emergency spillways can be incorporated into the levee design to maintain the structural integrity.

<sup>1</sup> Federal, state and local permits may have to be obtained for the placement of dredge or fill material into wetlands.

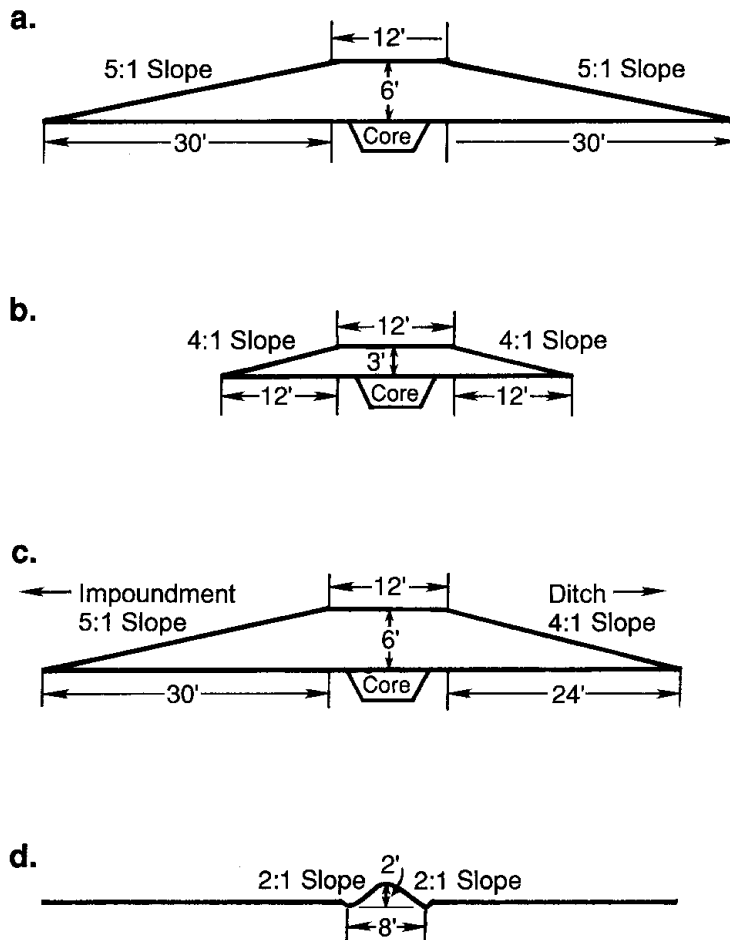

**Fig. 1** Dimensions of levee for a permanent or semipermanent impoundment (a), levee for a seasonally flooded impoundment (b), header-ditch levee (c), and rice-dike levee (d).

Levees that form header ditches should be constructed according to many of the same criteria as impoundment levees (Fig. 1c). However, the height of header-ditch levees should be based on the quantity and rate of water that must be transferred from the water source to the impoundment. The levee height should be a minimum of 1.5 feet (0.5 m) above the maximum planned water capacity of the ditch.

### *Temporary Levees*

Formerly, many impoundments were constructed without regard to natural topography, and elevation changes in excess of 3 feet (0.9 m) were common. Although small elevation changes promote plant diversity and provide a diversity of depths for foraging, the management of impoundments with large topographic variations can be impaired because water levels are difficult to manipulate. One method of improving the manipulation of water levels in such impoundments

is the construction of temporary levees, often called rice dikes. The dimensions of completed rice dikes vary by soil type and equipment, but those constructed with a rice-dike plow typically have steep side slopes, a base width of about 8 feet (2.4 m), and a height of about 2 feet (0.6 m; Fig. 1d). Small levees also can be constructed with terrace plows, fire plows, bulldozers, and motor graders. These implements can be used to develop levees with more gradual side slopes and greater heights, but construction is more costly and the amount of manageable habitat in an impoundment is reduced. Regardless of the construction method, small levees should be built only on well-drained soils to assure a dry, impervious core. Because rice dikes gradually taper toward the top, they are very susceptible to erosion from wave action. Consequently, most rice dikes are effective only if constructed on contours which prevent water from overtopping and eroding the levee. Rice dikes usually have a life-span of less than 2 years.

## Water-control Structures

Correct placement and type of water-control structures for precise manipulation of water levels are essential for the simulation of natural hydrologic regimes. Structures to regulate the water discharge should be placed at the lowest elevation in the impoundment and be large enough to permit complete, rapid dewatering. Stoplog structures have proven to be the most effective design because desired changes in water depth can be achieved with appropriately sized stoplogs and because water depths can be maintained with a minimum of monitoring (Fig. 2a). In contrast, screw gates are poorly suited as outlet structures

because they require constant monitoring during drawdowns and do not enable precise manipulations (Fig. 2b). However, screw gates may be used to regulate the water flow into an impoundment. The number and size of water-control structures should be determined by topography and size of the impoundment. Structures should be placed where management activities cause little disturbance of wildlife.

### *Flooding Systems*

A proper design of flooding systems is imperative to successful wetland management. If possible, each location for levees should be

### Stoplog water control structure

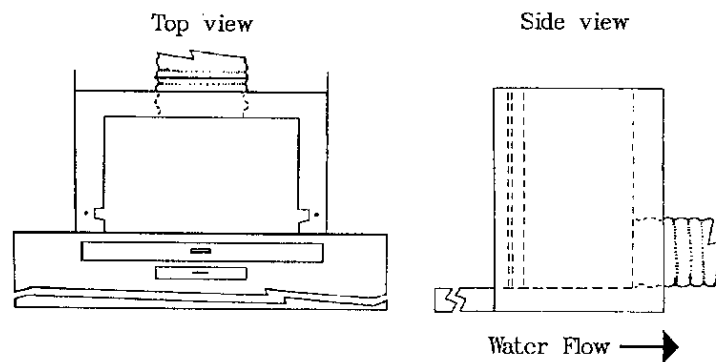

**Fig. 2.** Stoplog (a) and screw gate (b) water-control structures for manipulating water levels.

### Screwgate water control structure

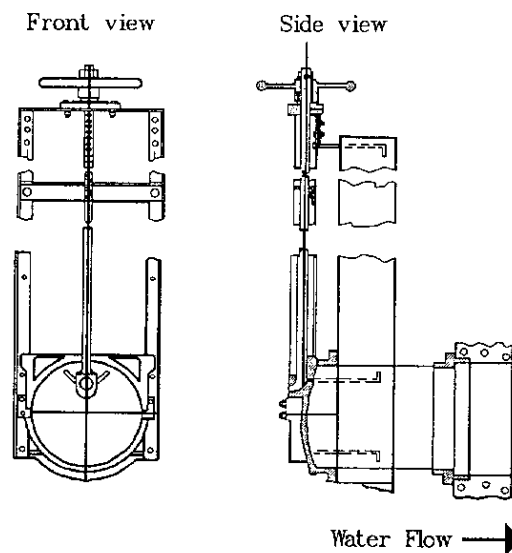

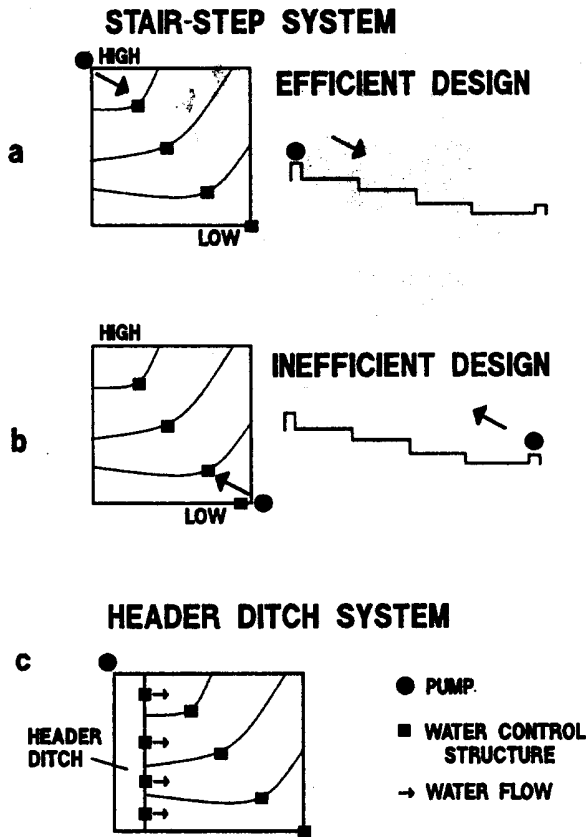

Fig. 3. Configuration of stair-step (a and b) and header-ditch (c) flooding systems.

developed to permit the independent control of the depth, duration, and time of flooding. Furthermore, a proper location of the pumping units is important for efficient water manipulation. Any of three methods generally are used to flood a complex of impoundments. The first is a stair-step overflow system (Fig. 3a and 3b). Ideally, the water enters at the highest elevation. When flooding commences, the area at the highest elevation is flooded first. Subsequent additions of water can be used to flood additional areas at lower elevations. Having the water enter at the highest elevation also ensures that it can flow through impoundments, making it possible to remove salts and to irrigate vegetation effectively. The second system requires the construction of a water transfer system adjacent to several areas with levees (Fig. 3c). Such a transfer system may consist of a header ditch or polyvinylchloride (PVC) pipe with water-control structures that independently regulate water flow into each impoundment. The use of a PVC pipe allows more

efficient use of water than a header ditch and never requires control of vegetation. However, the PVC pipe should be buried to prevent deterioration. A hydrologist or engineer should be consulted prior to the installation of a permanent pipe system because the distance that water can be transferred through a pipe varies with pump type, pipe size, and elevation gradient. The third flooding system consists of a portable pump with sufficient hose or pipe to transport water from the source (e.g., pond, ditch) to each impoundment.

### Dewatering Systems

The dewatering system is as important to successful wetland management as the flooding system. The discharge system should ensure the quick and complete removal of water from all impoundments. Thus, discharge ditches should be at least 2 feet (0.6 m) below the base elevation of an impoundment. Although the quantity of water that must be removed from impoundments determines the dimensions (i.e., base width, side slope) and the number of required discharge ditches, requirements for maintenance also should be considered. The ability to completely remove water from the discharge ditches prevents undesirable vegetation, such as American lotus or willows, from becoming established and reducing drainage capacity. If such problems develop, ditches with minimum side slopes of 4:1 permit equipment access to control vegetation and still promote efficient water removal.

### Benefits of Proper Development

The value of a properly constructed wetland can best be evaluated by comparing the costs of construction and maintenance with the benefits for wildlife. To illustrate the long-term costs and benefits of contour levees, compare a 1,000 acre moist-soil impoundment with contour levees and one with a single straight levee bisecting the unit (Fig. 4). The initial cost of construction is 320% greater with contour levees (Table), but water levels over the entire area can be managed to establish vegetation and food resources for water birds. In contrast, optimum water levels can be achieved on only 45% of the area if a levee were constructed across the elevation gradient. The remaining 55% will either be too deep for water birds or will remain dry.

**Levees constructed  
on contours**

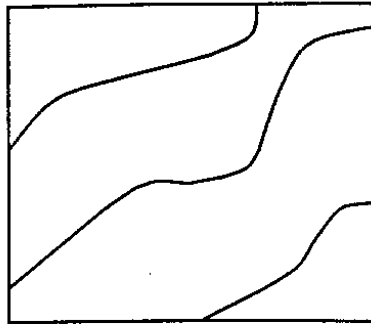

**100% effective  
management**

**Levees constructed  
across contours**

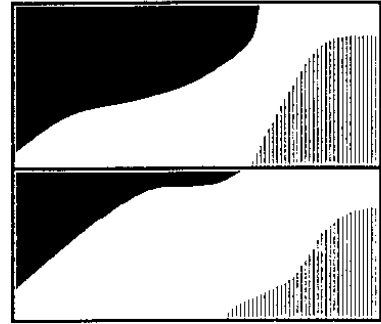

**45% effective  
management**

**Fig. 4.** Cost-benefit comparison of an impoundment with and without contour levees.

**Water depth**

**— Levee**



**Optimal**

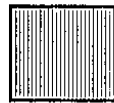

**Too  
deep**



**Dry**

**Table.** Construction costs for hypothetical 1,000-acre impoundments with levees on contours and with levees not on contours.<sup>a</sup>

Item	Levees on contour	Levees off contour	Difference
Amount of fill material (yd <sup>3</sup> )	51,371	16,054	35,317
Cost of interior levees (\$0.88/yd <sup>3</sup> )	45,206	14,127	31,079
Initial levee cost (\$/acre)	45.21	14.13	31.08
Effectively managed area (%)	100	45	55
20 year cost (\$/effective acre)	2.26	1.57	0.69
Effectively managed area in 20 years (acres)	20,000	9,000	11,000
Seed production in 20 years (million lbs)	30.0 <sup>b</sup>	4.5 <sup>c</sup>	25.5
Waterfowl use-days in 20 years (in millions; 0.2 lbs/day/bird)	150.0	22.5	127.5

<sup>a</sup> Conversions of measurements to metric units not given.

<sup>b</sup> Based on a seed-production rate of 1,500 lbs/acre/yr.

<sup>c</sup> Based on a seed-production rate of 500 lbs/acre/yr.

After 20 years, the impoundment with contour levees provides 11,000 more acres of managed habitat than the impoundment without contour levees. With the precise water-level control from proper levee placement, the annual moist-soil seed production may average 1,500 lbs/acre (275 kg/ha). In the impoundment without contour levees, the water-level control would be less precise and the annual seed production may average only 500 lbs/acre (92 kg/ha), of which a portion would be unavailable to birds because of deep water. The difference in the annual seed production would result in an additional 25.5 million pounds (about 11.6 million kg) of seed in the impoundment with contour levees during 20 years. This amount of food could support as many as 6.4 million additional waterfowl use-days/year.

Proper construction and placement of levees and water-control structures provide benefits not only for waterfowl. For example, of 80 water birds that commonly use wetlands in Missouri, more than 55 species use only shallowly flooded habitats (<10 inches [25.4 cm]). Many of these species are dependent on invertebrates, which also respond best to shallowly flooded environments. Other foods, including tubers and browse, also are more available to water birds if shallowly flooded. Thus, contour levees that permit shallow flooding over the entire impoundment are of great importance in meeting the needs of many wetland species. Including these factors in a cost-benefit analysis would make contour levees an even more attractive alternative.

## Recommendations

In summary, recommended specifications for the development of managed wetlands are:

1. The simulation of natural hydrologic cycles.
2. Independent water delivery and water discharge for each impoundment.
3. Water delivery at the highest elevation.
4. Water discharge at the lowest elevation.
5. Stoplog structures as the most appropriate outlet structures.
6. Levees on contours.
7. Maximized flooded area to shallow depths (<10 inches [<25 cm]).
8. Water-control structures, pumps, and other structures placed where they and their maintenance cause the least disturbance to wildlife.

## Suggested Reading

- Fredrickson, L. H., and T. S. Taylor. 1982. Management of seasonally flooded impoundments for wildlife. U.S. Fish and Wildlife Service Resource Publication 148. 29 pp.
- Payne, N. F. 1992. Techniques for wildlife habitat management of wetlands. McGraw-Hill Inc., New York, N.Y. 549 pp.
- Smith, L. M., R. L. Pederson, and R. M. Kaminski, editors. 1989. Habitat management for migrating and wintering waterfowl in North America. Texas Tech University Press, Lubbock. 560 pp.

## Appendix. Common and Scientific Names of the Plants and Animals Named in the Text.

---

### Animals

Beaver . . . . .	<i>Castor canadensis</i>
Nutria . . . . .	<i>Myocaster coypus</i>
Muskrat . . . . .	<i>Ondatra zibethicus</i>

### Plants

American lotus . . . . .	<i>Nelumbo lutea</i>
Willows . . . . .	<i>Salix</i> spp.

---

**Note: Use of trade names does not imply U.S. Government endorsement of commercial products.**

UNITED STATES DEPARTMENT OF THE INTERIOR  
NATIONAL BIOLOGICAL SURVEY  
*Fish and Wildlife Leaflet 13*  
Washington, D.C. • 1993